

ANALYSIS OF SEISMIC AND VIBRATION CAPACITIES OF THE WWER-1000 CONTROL ROD DRIVE SYSTEM.

Berkovski A., Kostarev V., Schukin A. (CKTI-Vibrozeism, St. Petersburg, Russia)

ABSTRACT

This paper presents the results of experimental and computer analyses of seismic margin capacity and operability under abnormal vibration of PWR (WWER) Control Rod Drive System (CRDS). A special PC computer program "SEISM-2000" for non-linear dynamic analysis of CRDS has been developed and verified regarding to shaking table experiment of the CRDS ¼ scale model. The result of experiment and analysis show high sensitivity of the PWR CRDS operability to seismic and vibration loading.

INTRODUCTION

In recent years the international community gives the big emphasis to the problem of seismic qualification of the WWER-type NPP in Eastern Europe. One of the most important and complicated safety-related system of these NPPs is the Control Rod Drive System (CRDS). This system should be capable for reliable controlling reactivity changes either under conditions of anticipated normal plant operational occurrences, or in withstanding the effects of postulated accidents and natural phenomena such as earthquakes [1, 2]. On the other hand the experiments have shown the essential sensitivity of CRDS operability to seismic and vibration loading [3, 4].

Basically there are two main possibilities to obtain seismic margin and dynamic capacities of CRDS. The first one is rather expensive shaking table or on site testing of full scale model of CRDS. The second way is using of SMA or GIP methodology. Their implementation is connected with principle obstacles of: a) too complicated non-linear parameter-dependent structure of WWER CRDS for analytical study and verifying problems and b) lacking of experimental data base. Although this way seems more preferable since there is a possibility to vary different model parameters to find out the weak links of structure and to define the reliable range of CRDS seismic and operational vibration capacities.

That is why the special study of the above pointed problem was undertaken in the frame of IAEA Benchmark Study for Seismic Analysis and Testing of WWER-type Nuclear Power Plants.

The present investigation consists of the following stages:

- defining of seismic safety requirements and criteria;
- developing of ¼ scale CRDS model and its shaking table seismic and vibration tests;
- developing of PC computer code "SEISM 2000" for non-linear dynamic analysis of CRDS;
- verifying of "SEISM-2000" program according to experimental results;
- analysis of WWER -1000 CRDS operability under seismic excitation.

SEISMIC SAFETY REQUIREMENTS AND CRITERIA FOR THE CRDS.

One of the most important requirements for CRDS is the reliability of the control rods insertion during any operation conditions including earthquake and other dynamic impacts.

To provide the nuclear safety CRDS should meet the following requirements [1-6]:

- the reliable Control Rods movement in the direction of reactivity decreasing;
- limitation of the reactivity increasing time;
- extremely low probability of Control Rods throwing up from active reactor zone;
- guarantee of the Control Rod inserting speed;
- reliable releasing of the Control Rod assembly under AZ mode;
- Loss of Coolant Accident prevention;
- reliable cooling of the CRDS.

On the basis of all these requirements it is possible to formulate the acceptance criteria for dynamic behavior of CRDS under seismic impact. Obviously that after beginning of earthquake the emergency situation may be occurred. Thus, in this mode the main function of CRDS is inserting control rods in the reactor active zone to timely decrease reactivity of the system. However, it can be assume that due to large response dynamic displacements and accelerations the stuck rod can occur and then the operating time of CRDS may be beyond determined limits.

In regard to WWER CRD System according to all above pointed circumstances the following requirements should be satisfied during postulated SSE:

1. The CR movement in AZ mode shall be provided by means of gravity force and reactivity of reactor shall be controlled by the value of the rod insertion time.
2. The CR insertion speed in AZ mode shall be limited by physical characteristics of reactor.
3. The requirements to CRDS mechanism, nozzles and housing strength should be satisfied to prevent LOCA and throwing up the CRs from reactor active zone by pressure so as by vertical seismic excitation.
4. The operability of CRDS in AZ mode should be provided to avoid the changing of insertion time beyond the limits, latching and stuck of Control Rods.
5. On the basis of all these requirements it is possible to conclude, that the parameter of Control Rod Insertion time is the evident governing criteria for seismic capacity of CRDS.

EXPERIMENTAL BACKGROUND FOR CRDS SEISMIC SAFETY REQUIREMENTS

In recent years CKTI-VIBROSEISM has performed a number of shaking table and on site testing of various constructions of WWER CRDS. Among them are: WWER-440-213 CRDS, WWER-1000 CRDS with linear step-by-step driver and servo-drivers for RBMK- 1000/1500 type reactor. On site investigation of the Novovoronez NPP WWER-1000 CRDS dynamic characteristics has been carried out to determine natural frequencies of CRDS housing (upper block) in assembly.

These experiments have clearly shown that the time-delay of armature drop-down is belonged due to high level of response acceleration and consequently large deflections in the middle part of housing under sub-resonance and resonance modes of vibration [4].

Description of the Shaking Table Test.

The experimental investigations of VVER - 440 CRDS 1/4 scale model seismic and vibration capacities have been carried out on the CKTI-VIBROSEISM 20 tons, 1-D horizontal Shaking Table. This platform was specifically designed for all kinds of dynamic testing, including seismic loading of the full scale CRDS for VVER-440, 1000 MWt reactors, Figure 1.

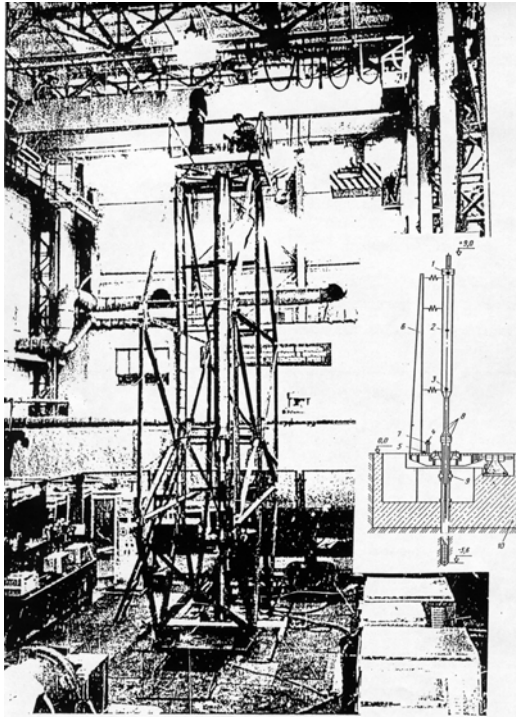

Figure 1 The WVER-440 CRDS ARK-type on the CKTI Vibroseism 20-tons Shaking Table

The shaking table PC Control System is based on Analogue-Digital-Analogue Converters and allows to set the sinusoidal sweep excitation, static displacements of the table, multi-harmonic excitation, random dynamic so as seismic excitation.

The vibration measurements on shaking table tests have been carried out by PC multi-channel complex "MERA" (Russia) and "Bruel & Kjer" (Denmark) instrumentation.

The CRDS Model

Following the goal of the study the CRDS model has to reflect all important peculiarities and dynamic properties of natural scale CRDS that can influence on its seismic and vibration capacities. To achieve this task is not necessary to make a full copy of CRDS but only to reproduce the main inertia, material, stiffness, gap and other properties of CRDS so as

interaction of internal elements in order to receive complete verification data.

The specific side of the CRDS modeling is the necessity of taking the acceleration model coefficient equal to "1" for modeling the operability of CRDS under AZ mode of the rod (rack) free insertion and seismic excitation. The tested structure is the 1/4 scale simplified geometric model of the WVER-440 ARK CRDS with the following model scales:

Time	Material	Linear scale	Displacement	Frequency	Velocity	Mass
0.5	1.0	0.25	0.25	2.0	0.5	0.015625

Methodology

The Paks NPP Design Spectra (elevation 18 m) have been chosen for generating TH accelerograms for testing of CRDS model and verifying of "SEISM-2000" program. The duration of model excitation was equal to 10 seconds and ZPA level has been varied from 0 up to 0.72g.

The main criteria of CRDS operability/seismic capacity is the time of rack inserting (free fall) in AZ mode which is limited for natural scale CRDS by the range of 8.5 - 12.8 seconds. It corresponds to average velocity of the rack insertion in limits of 300 - 200 mm/s. For the

CRDS model these parameters have to be reduced according to scale coefficients and have to be measured during the test running.

Results of the CRDS model testing

The initial stage of experiment was to determine the first natural frequency and damping characteristics of the CRDS model. This test has been performed with upper and lower positions of the rack and shows that the first mode and damping parameters are the same for these two cases: $f = 4.6$ Hz and $k = 0.013$ (1.3%) respectively.

The investigation of seismic and vibration excitation influence on CRDS rack free insertion in AZ mode have been performed with ten levels of seismic wave accelerations from 0 up to 0.72 g. Five experiments with statistical processing of results have been fulfilled for each level of seismic acceleration.

The analyses of results show rather good reproducing and repetition of shaking table parameters and CRDS model response and makes clear that the rack is working like non-linear gap dynamic damper in rod bearings.

The main results of seismic excitation influence on CRDS rack free insertion in AZ mode are shown on figures 2, 3. The plots are illustrated the dependencies of average free fall insertion of the CRDS rack from intensity of earthquake excitation. It is clear that the Mean +/-

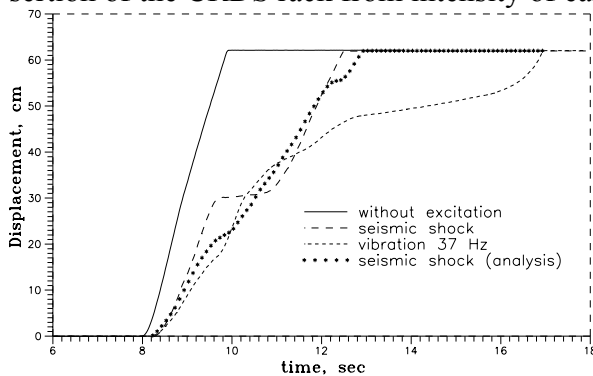

Figure 2 Time-Displacement Dependencies of the CRDS Rack Insertion in AZ Mode under Safe Shutdown Earthquake and Abnormal Operational Vibration (Experiment & Analysis)

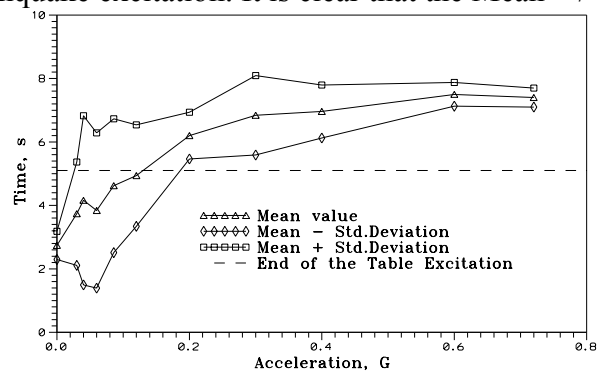

Figure 3 Influence of the CRDS Rack Free Insertion Time in AZ Mode from the Peak Acceleration Level of Seismic Excitation

standard deviation zone of results becomes more narrow with increasing of seismic impact intensity. It is also possible to conclude that the time of rack insertion is limited mainly by duration of excitation and can for 2-6 times increases in comparison with design AZ mode time. In operational vibration testing of the CRDS model the frequency of harmonic excitation was tuned to one of the resonant frequencies of the rack: 37 Hz. It is equal to 18.5 Hz mode of natural scale CRDS. The vibration of the rack greatly influences on the CRDS free insertion time and depends primarily from interaction processes in "Rack - Bearings" system, Figure 2.

COMPUTER CODE SEISM-2000 AND RESULTS OF COMPARATIVE EXPERIMENTAL AND ANALYTICAL STUDY

SEISM-2000 is the computer software program developed for analytical investigation of the non-linear systems whose parameters and characteristics are changed during the dynamic process. The background for developing of SEISM-2000 is the component-element method (CEM) [7] combined with the finite-element method (FEM). To solve the difference equations of motion the direct integration method in terms of central finite differences is used.

The program provides the dynamic time-history analysis with finite-element approximation of beam-type elements and systems with concentrated parameters (lumped mass, stiffness, damping, etc.). The library of non-linear elements includes a number of components. Among them are: elastic spring element; viscous damper element; constant friction element; variable friction element (the reaction force in this element depends from reaction in other described early element and treated by program as friction force); limit stop; moving limit stop (this element takes into account, for example, interaction between moving inserting rod and external construction); hydraulic damper, snubber or any other device with non-linear characteristics; bearing, etc.

To create the analytical model the geometry and properties of experimental 1/4 scale

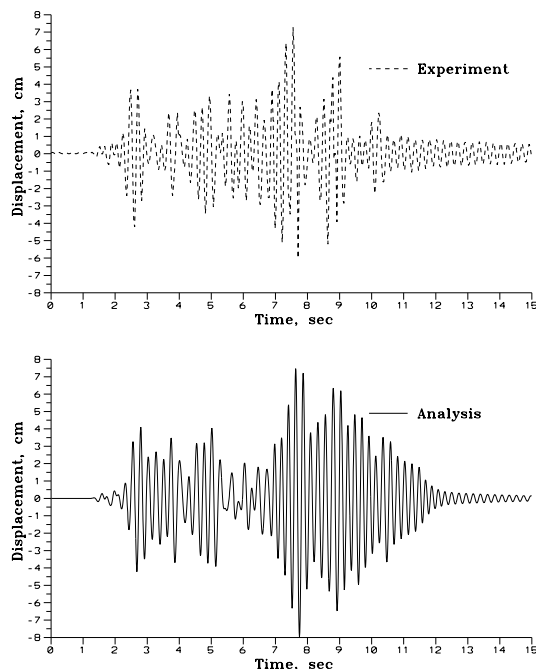

Figure 4 Experimental and Analytical Response Vibration of the CRDS Housing under identical Time History Seismic Excitation

The results of the comparative experimental and computer analyses show appropriate agreement in main dynamic parameters, such as natural frequencies, displacements and time of the rod insertion in spite of evident non-linear effects presence, figure 4. These results permit to conclude that the SEISM-2000 program performs good enough and may be used in solving of practical tasks in non-linear dynamics [4].

model of CRDS have been used. From experimental data the damping ratio for whole construction was determined too. The time of the control rod's insertion is defined by the complex of kinematics parameters of CRDS including dry friction in the bearings of drive mechanism and hydraulic resistance of moving parts of construction. These peculiarities of the construction have been modeled by means of friction elements and viscous damper element respectively.

The following modes were chosen for comparison:

- free insertion of the control rod without external impacts;
- free oscillation of the supporting frame;
- dynamic behavior of the system under external excitation of 0.6g.

The total time of seismic excitation (the same to experiment) was set to 10 second and there was 4 second more of real time computer analysis to record the free oscillations of the system after the impact completing.

The results of the comparative experimen-

ANALYSIS OF THE WWER-1000 CRDS SEISMIC CAPACITY.

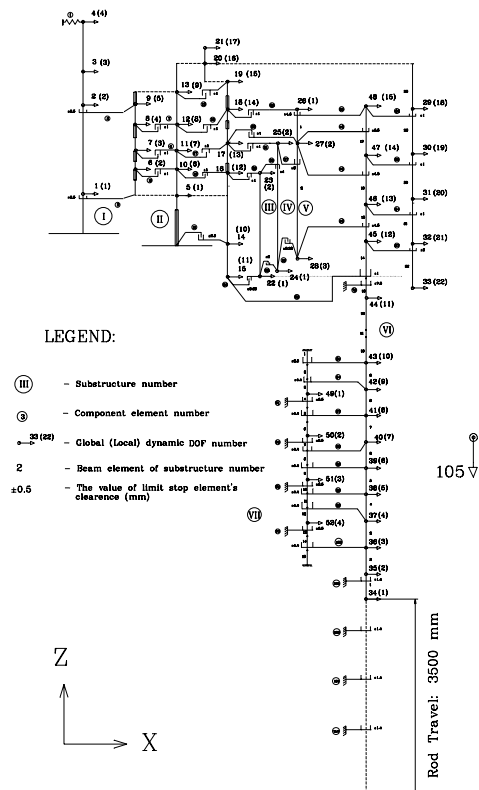

Figure 5 WWER-1000 CRDS Analytical Model for Non-Linear Time History Seismic Analysis

Successful experimental verification of the SEISM-2000 computer code allows to perform seismic and vibration analytical margin assessment of the NPP systems where interaction, parameter and non-linear dynamic effects between elements are governing. Further is the example of such analysis for WWER-1000 Control Rod System, Figure 5.

Input Seismic Excitation

The floor response spectra corresponding to $PGA_{SSE} = 0.1g$ was assumed as an input excitation. To analyze CRDS the floor response spectra on the level of +28.0 m of the reactor building were accepted as design response spectra.

Since all analyses were fulfilled by means of THA method three artificial acceleration time histories - two horizontal and one vertical have been generated from the design response spectra to reflect carefully the target spectra. These synthetic accelerograms was developed by computer code SPECTRA and satisfy the requirements of the ASME BPVC Appendix N (chapters N-1212, N-1213).

Analytical model of the WWER-1000 CRDS

To create the dynamic analytical model of CRDS the following assumptions and idealizations were made:

1. All components of the CRDS were modeled by beam finite elements with concentrated inertial parameters.
2. The experimental data the damping ratio was accepted.
3. All non-linear peculiarities of the CRDS were modeled by means of component elements.
4. The analytical model reflects all kind of forces that effect in the CRDS: active (gravity) and passive (pressure difference, hydraulic reactive and buoyant) forces [8].
5. All assumptions and idealizations in the analysis had the moderate conservative character.
6. It was assumed, that in AZ mode the control rod separates from drive mechanism practically immediately, when the electromagnetic system losses its power.

The analytical model of the WWER-1000 CRDS is shown on the figure 5. These analytical model consists of a number of beam substructures. All these substructures are connected with corresponding component elements. For example the elements "moving limit stop" imitate the interaction between inserting control rod and internal housing elements (collisions take place in the housing clearances). The horizontal reaction appears as result of these shocks. This reaction induces the vertical friction force. Thus, the additional slowing down of rod insertion (stuck rod) is the result of this force action.

Analyses results

On the first stage the influence of vertical seismic excitation has been analyzed. It is the most important problem since the critical reverse vertical displacements of FLM closing pipe along FLM housing is equal 5.0 mm. In case of overcoming of this limit the stuck rod can occur. The figure 6 demonstrates that the peak amplitude displacement described above is below the allowable 5 mm limit.

The second type of analysis which has been undertaken was the investigation of the three-component seismic excitation influence on dynamic behavior of CRDS and determination of CR time insertion in AZ mode. The figure 7 shows that the maximum difference between AZ mode CR time insertion with and without seismic excitation achieves 1.35 second that means 45 % increasing of CR insertion time under Normal Operation Conditions. It is absolutely clear that PGA_{SSE} level more than 0.1g can lead to heavy dropping down of the CRDS seismic capacity.

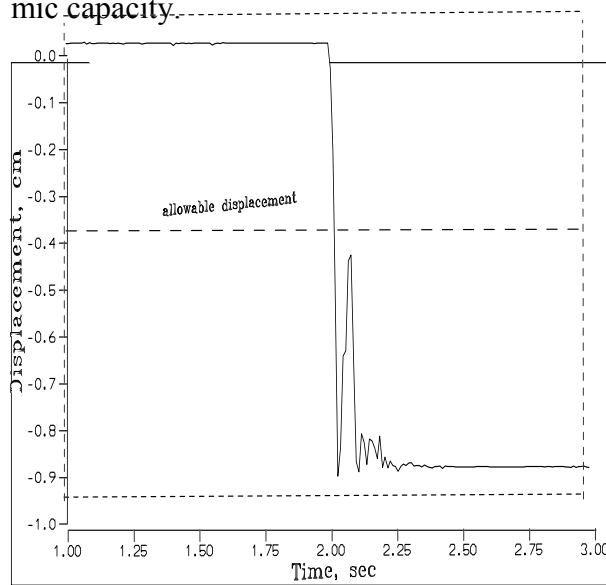

Figure 6 WWER-1000 CRDS Rod Travel in AZ Mode under $ZPGA_{SSE}=0.1g$ Earthquake (the line of allowable vertical displacement shows the limit seismic capacity of CRDS)

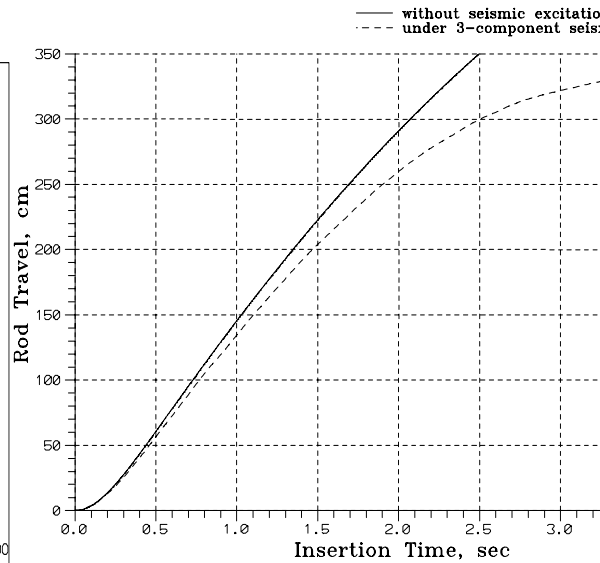

Figure 7 CRDS Rod Insertion (Travel) with and without Seismic Excitation (AZ Mode CRDS Startup on the 2-nd second of Earthquake, $ZPGA_{SSE}=0.1g$)

CONCLUSIONS

1. The complex of experimental and analytical study of the PWR (WWER) Control Rod Drive System seismic and vibration capacities have been carried out.
2. To analyze dynamic behavior of CRDS the computer code SEISM-2000 has been developed and successfully verified against experimental results.
3. The investigations of CRDS seismic and operational vibration capacities have shown that dynamic excitation can heavily increase the time of CRDS accident insertion and influence greatly on nuclear and seismic safety of NPPs.

REFERENCES

1. Control Rod Drive System, *USNRC STANDARD REVIEW PLAN*, Section 3.9.4 Rev. 2 - April 1984
2. Емельянов И.Я. и др., *Основы конструирования исполнительных механизмов управления ядерных реакторов*, Москва, Энергоатомиздат, 1987, 232 с
3. Абрамов В.Н., Ветошкин В.А., Костарев В.В., Щукин А.Ю., Масленок Б.А., Экспериментальное исследование сейсмостойкости привода СУЗ, *Труды ЦКТИ*, 1980, вып. 182, стр. 117-122
4. Kostarev V.V., et. al., Experimental and Computer Analyses of Control Rod Drive System Seismic Capacity, *13 Post - SMIRT Conference*, Iguasa, Argentina, august, 1995
5. *ASME Boiler and Pressure Vessel Code*, Section III, Division 1, Edition 1992. ASME, New York, 1992
6. ПИНАЭ Г-7-002-86, *Нормы расчета на прочность энергетического оборудования и трубопроводов АЭУ*
7. S. Levy, J.P. Wilkinson, *The Component Element Method in Dynamics*, McGraw Hill IBC, 1976
8. Ионайтис Р.Р., Стобецкий В.Н., *Гидравлика СУЗ ядерных реакторов*, Атомиздат, М., 1972